



nuova

**SIMONELLI**<sup>®</sup>

espresso coffee machines

---



**MUSICA**

---

***LIBRETTO ISTRUZIONI***

***USER HANDBOOK    MANUEL D'INSTRUCTIONS    GEBRAUCHANWEISUNGEN    INSTRUCCIONES DE MANEJO***

---

**DICHIARAZIONE DI CONFORMITÀ CE**  
**EC DECLARATION OF CONFORMITY**



**nuova simonelli**  
*espresso coffee machines*

Via M. D'Antegiano, 6 - 62031 Belforte del Chienti (MC)

dichiariamo, sotto la nostra responsabilità, che il prodotto:  
*declare under our responsibility that the product:*

**MACCHINE PER CAFFÈ ESPRESSO**  
**MODELLO: MUSICA**

*ESPRESSO COFFEE MACHINES*  
*MODELS: MUSICA*

al quale si riferisce questa dichiarazione, è costruito in conformità alle disposizioni:  
*to which this declaration relates, following the provisions of the Directives:*

**EN 60335-2-15:2002 + A1:2005 + A2:2008**  
**in combination with**  
**EN60335-1:2002 + A11:2004 + A1:2004 + A12:2006 + A2:2006 + A13:2008**  
**EN62233:2008**

ed è conforme alle direttive  
*following the provisions of the Directives*

**2006 / 95 / CE Low Voltage**  
**2004 / 108 / CE (EMC)**

data: **Novembre 2009**  
**November 2009**

**nuova simonelli s.p.a**  
*L'Amministratore Delegato*  
*(Ottavi Nando)*

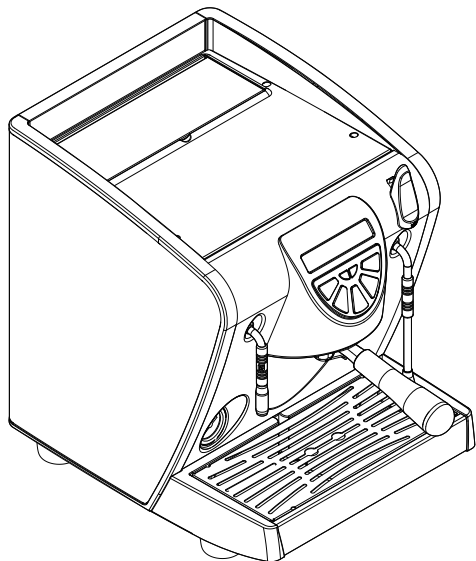

Congratulations, upon the wise choice you have made by purchasing the **MUSICA** model. In fact, you are now the owner of not just a simple coffee dispenser, but a true espresso coffee-making machine which is fully automatic and completely controlled by a microprocessor. This means absolute reliability and simple to use. We are certain that our **MUSICA** model will increase your confidence in **Nuova Simonelli** and that you will undoubtedly recommend others to purchase this coffee-making machine, since the **MUSICA** model has been chosen to increase the profitability of the coffee shop, thus fully optimising running costs. This machine has been manufactured in compliance with the EEC directives 89/392, 89/336, 73/23, 89/109 and subsequent modifications. With best wishes

**Nuova Simonelli S.p.a.**

## TECHNICAL CHARACTERISTICS

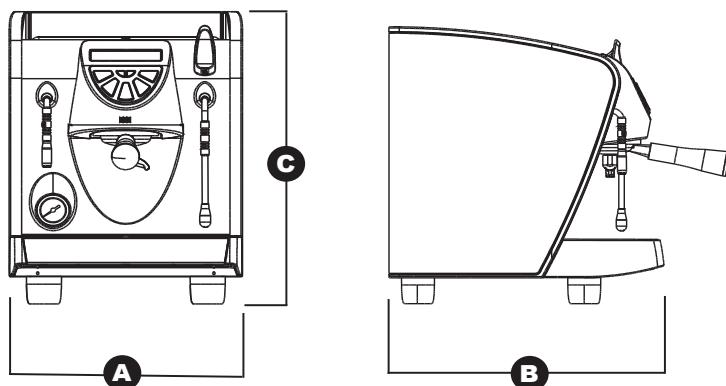

MODELS	NET WEIGHT	GROSS WEIGHT	HEATING CAPACITY	DIMENSION		
				A	B	C
MUSICA	20 Kg	23 Kg	1200W	320 mm	400 mm	430 mm
	44.1 lb	50.7 lb		12.6 inc	15.7 inc	16.9 inc

## CONTENTS

	<b>TECHNICAL CHARACTERISTICS .....</b>	<b>page 15</b>
<b>1.</b>	<b>GENERAL DELIVERY NOTES .....</b>	<b>page 17</b>
<b>2.</b>	<b>SAFETY INDICATIONS .....</b>	<b>page 17</b>
<b>3.</b>	<b>SHIPPING AND HANDLING .....</b>	<b>page 20</b>
3.1	Machine Id .....	page 20
<b>4.</b>	<b>DESCRIPTION .....</b>	<b>page 21</b>
4.1	Description of control panel .....	page 22
<b>5.</b>	<b>INSTALLATION .....</b>	<b>page 23</b>
<b>6.</b>	<b>PROGRAMMING .....</b>	<b>page 24</b>
6.1	programming doses .....	page 24
6.2	Coffee dose programming .....	page 24
6.3	Programming hot water .....	page 24
6.4	Programming standard doses .....	page 24
6.5	Additional functionse .....	page 24
<b>7.</b>	<b>USE .....</b>	<b>page 25</b>
7.1	Switching the machine on/off .....	page 25
7.2	Making coffee .....	page 25
7.3	Using steam .....	page 25
7.4	Making cappuccino .....	page 26
7.5	Hot water selection .....	page 26
7.6	Tank filling .....	page 26
<b>8.</b>	<b>SWITCHING OFF THE MACHINE .....</b>	<b>page 26</b>
<b>9.</b>	<b>MAINTENANCE .....</b>	<b>page 26</b>
<b>10.</b>	<b>CLEANING .....</b>	<b>page 27</b>
<b>11.</b>	<b>TROUBLESHOOTING .....</b>	<b>page 28</b>

## 1. GENERAL DELIVERY NOTES

The machine and all parts are generally delivered in palletized cartons. Upon receipt check that:

1. All packaging is intact.
2. The contents are the:
  - a. Machine.
  - b. Box of accessories:
 

b0. Two-cup filter	b1. Filter spring
b2. Filter holder	b4. Coffee measure
b5. Coffee press	b6. Single-cup filter
3. The machine and accessories are not damaged in any way.

In case of damage or missing pieces, immediately contact the manufacturer or its sales agent in your area or its insurance company.

## 2. SAFETY INDICATIONS

 The present manual is an integral and essential part of the product and is to be delivered to the user. Carefully read all warnings in the manual as they provide important information required to install, use and maintain the unit safely. Keep this manual in a safe place for further consultation.

 After having removed the packaging, make certain that the unit is not damaged in any way. If you have any doubts, do not use the unit and contact a professionally qualified person. Always keep all packaging (plastic bags, polystyrene foam, nails, etc.) out of the reach of children as they are a potential source of danger and never loiter the environment with such materials.

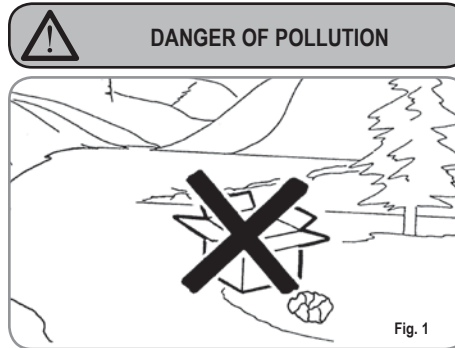

 Before turning on the unit make certain that the rating indicated on the label matches the available power supply. The label is located under the machine work base at the upper right.

Installation must be performed following the standards in force in the country where it is being installed and following the manufacturer's instructions. Only skilled personnel can install this unit.

The manufacturer cannot be held responsible for any damages incurred if the system is not grounded.

For electrical safety, this machine requires a ground system. Contact a technically certified electrician who must check that the line electrical capacity is adequate for the maximum capacity indicated on the unit label.





The electrician must also check that the line cables have adequate section to handle the power absorbed by the unit. Never use adapters, multiple jacks or extension cords. When such items prove absolutely necessary, call in a qualified electrician.

 When installing the device, it is necessary to use the parts and materials supplied with the device itself. Should it be necessary to use other parts, the installation engineer needs to check their suitability for use in contact with water for human consumption.

 The machine must be installed in compliance with the local health standards in force for plumbing systems. Therefore, contact an authorized plumber.

 The device needs to be supplied with water that is suitable for human consumption and compliant with the regulations in force in the place of installation. The installation engineer needs confirmation from the owner/manager of the system that the water complies with the requirements and standards stated above.

 This unit must only be used for the purposes described in the present manual. The manufacturer cannot be held responsible for any damages caused by improper, mistaken and unreasonable use.

 The appliance is not to be used by children or persons with reduced physical, sensory or mental capabilities, or lack of experience and knowledge, unless they have been given supervision or instruction.

 This appliance is for professional use only.

 The operating temperature must be within the range of [+5, +35]°C.

 At the end of installation, the device is switched on and taken to rated operating conditions, leaving it in a state in which it is "ready for operation".

The device is then switched off and the whole hydraulic circuit is bled of the first lot of water in order to remove any initial impurities.

The device is then refilled and taken to rated operating conditions.

After reaching the "ready for operation" condition, the following dispensing operations are carried out:

- 100% of the coffee circuit through the coffee dispenser (for more than one dispenser, this is divided equally);
- 100% of the hot water circuit through the water dispenser (for more than one dispenser, this is divided equally);
- opening of each steam outlet for 1 minute.

At the end of installation, it is good practice to draw up a report of the operations.



**WARNING**

Before using the machine, read this manual in its entirety or, at the very least, read the safety and set up instructions.

There are some basic rules for the use of any electrical appliance. In particular:

- never touch the unit with wet hands or feet;
- never use the unit with bare feet;
- never use extension cords in areas equipped with baths or showers;
- never pull on the power supply cord to unplug the unit;
- never leave the unit exposed to atmospheric agents (rain, direct sunlight, etc.);
- never let children, unauthorized personnel or anyone who has not read this manual operate the unit.

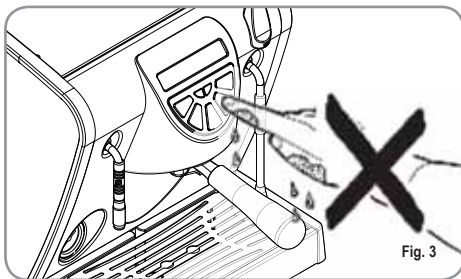
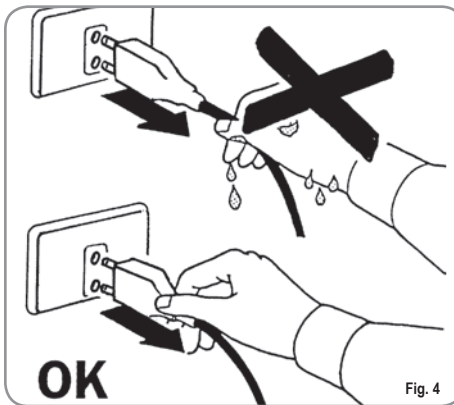

Fig. 3



**OK**

Fig. 4

Before performing any sort of maintenance, the authorized technician must turn off the unit and unplug it from the mains.

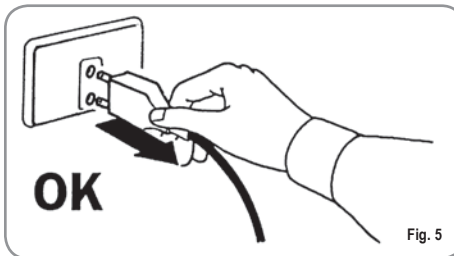

**OK**

Fig. 5

Before cleaning the unit set it in a state of "0" energy: that is, "MACHINE SWITCHED OFF AND UNPLUGGED". Follow the instructions given in this manual carefully.

In case of breakdown or poor function, turn off the unit. Never tamper with the unit. Contact only professionally qualified personnel.

Only the manufacturer or an authorized service center can make repairs and only using original spare parts. Non compliance with the above can compromise machine safety.

Upon installation, the qualified electrician must arrange for an omnipolar switch, as called for by the safety regulations in force; when open, the contacts must be 3 mm or more apart.

To prevent dangerous overheating, it is advisable to fully extend the power supply cord.

Never block the intake and/or heat dissipation grills, in particular those for the cup warmer.

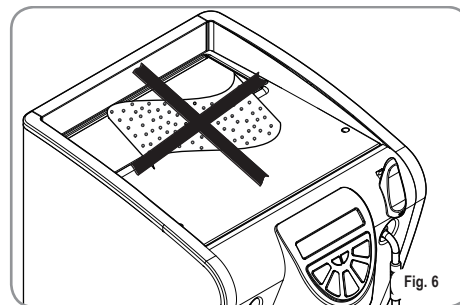

Fig. 6

The user must never replace the unit's power supply cord. If this cord is damaged, turn off the unit and have it replaced by a professionally qualified technician.

Should you decide to stop using this type of unit, we suggest you render it inoperable by unplugging it and cutting the power supply cord.





**WARNING  
 DANGER OF POLLUTION**



Fig. 7

 Never dispose of the machine in the environment: to dispose of the machine, contact an authorized center or contact the manufacturer for pertinent indications.

 To facilitate aeration of the unit, position the aeration portion of the machine 15 cm (5,9 in) from walls or other machinery.

 Once you have started washing the machine, complete the job or residues of detergent could be left inside the dispensing assembly.





**WARNING**  
**DANGER OF INTOXICATION**

 Be extremely careful when using the steam nozzle. Never place your hands under the nozzle and never touch it right after use.

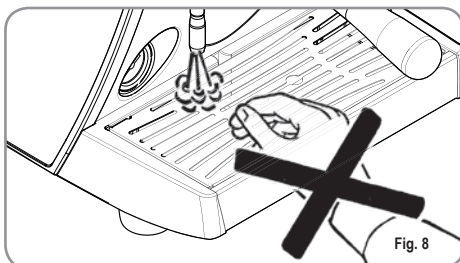

**WARNING**



 Remember that to install, maintain, unload and regulate the unit, the qualified operator must always wear work gloves and safety shoes.

 When adding the coffee, the operator must never put his hands into the container.

 The noise level of the machine is less than 70db.

 For machines connected to the mains water supply, the minimum pressure must be 0.6 MPa and the maximum pressure for correct machine operation must not exceed 1.3MPa.



**CAUTION**



**INFORMATION TO THE USERS**

Under the senses of art. 13 of Law Decree 25th July 2005, n. 151 "Implementation of the Directives/Guidelines 2002/95/CE, 2002/96/CE and 2003/108/CE, concerning the reduction of the use of dangerous substances in electric and electronic equipment, as well as the disposal of wastes".

The symbol of the crossed large rubbish container that is present on the machine points out that the product at the end of its life cycle must be collected separately from the other wastes. The user for this reason will have to give the equipment that got to its life cycle to the suitable separate waste collection centres of electronic and electrotechnical wastes, or to give it back to the seller or dealer when buying a new equipment of equivalent type, in terms of one to one. The suitable separate waste collection for the following sending of the disused equipment to recycling, the dealing or handling and compatible environment disposal contributes to avoid possible negative effects on the environment and on the people's health and helps the recycling of the materials the machine is composed of. The user's illegal disposal of the product implies the application of administrative fines as stated in Law Decree n.22/1997" (article 50 and followings of the Law Decree n.22/1997).

### 3. SHIPPING AND HANDLING

#### 3.1 MACHINE ID

When communicating with the manufacturer **Nuova Simonelli**, always cite the machine ID number.

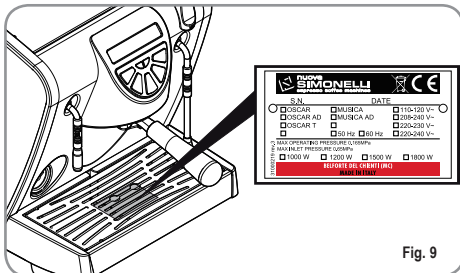

Fig. 9

The machine is transported on pallets containing several machines inside cartons strapped to the pallet.

Operators performing any shipping or handling operations must:

- wear gloves, safety shoes and overalls with elasticized cuffs.

Always move pallets using adequate equipment (i.e. fork lift trucks).



**CAUTION**  
DANGER OF IMPACT  
OR PINCHING

During handling, the operator must make certain that there are no persons, things or objects in the vicinity.

Slowly lift the pallet approximately 30 cm (11,8 in) off the ground and drive to the loading zone. After having made certain that there are no obstacles, things or persons in the way, proceed with loading.

Once the destination has been reached, again using adequate lifting equipment (i.e. fork lift truck) and after having made certain that there is nothing and no one in the unloading area, set the pallet on the ground and move it to the storage area; always carry the load at a height of approximately 30 cm (11,8 in) from the ground.



**CAUTION**  
DANGER OF IMPACT  
OR PINCHING

Before performing the following operations, make certain that the load is in stable and will not fall when the straps are cut.

Wearing gloves and safety shoes, the operator must cut the straps and store the product.

During this operation, see the product technical features for the weight of the machine being stored and proceed as necessary.



**CAUTION**  
DANGER OF POLLUTION

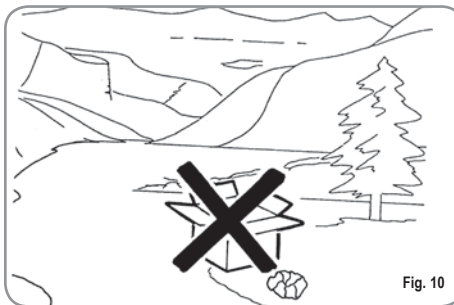
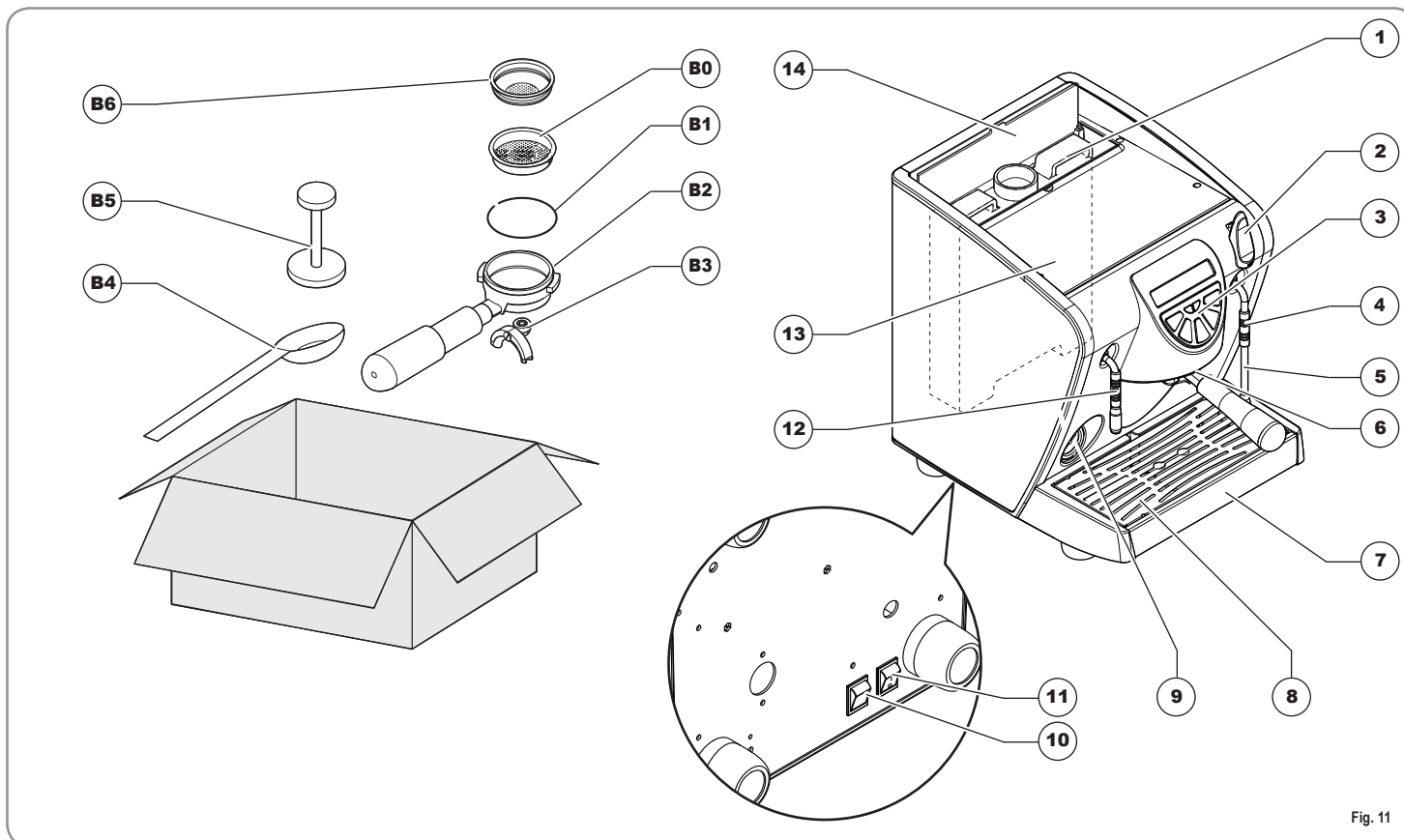

Fig. 10

Once the machine has been released from the pallet or container, do not pollute the environment with these items.



## 4. DESCRIPTION



ENGLISH

Fig. 11

### LEGEND

- b0** Two-cup filter.
- b1** Spring.
- b2** Filter holder.
- b3** Coffee nozzle.
- b4** Coffee measure.
- b5** Coffee press.
- b6** Single-cup filter.

### LEGEND

- 1** Water reservoir.  
The reservoir can hold 2.3 liters of water. Although the unit can operate with any type of water, the lower the water hardness the longer the unit will last.
- 2** Steam knob.  
Turn the knob and adjust the jet of steam.
- 3** Control panel.
- 4** Insulating socket.
- 5** Moveable steam nozzle.  
Delivers steam to heat liquids in containers.

- 6** Delivery assembly attachment.  
Filter holder housing (**b1**).
- 7** Water drain tank.
- 8** Cup support grill.
- 9** Pressure gauge.
- 10** Machine power switch.
- 11** Light switch.
- 12** Hot water dispenser wand.
- 13** Cup warming shelf.
- 14** Water reservoir hatch.

## 4.1 DESCRIPTION OF CONTROL PANEL



Fig. 12

### LEGEND

- |   |  |
|---|--|
| <p><b>15</b> Boiler tank heating element indicator light.</p> <p><b>16</b> Machine on/off switch.<br/>Hold down for 2 seconds to switch the machine on or off.</p> <p><b>17</b> 2 coffee dispensing button.</p> | <p><b>18</b> Continuous coffee dispensing button.<br/>Press to dispense coffee.<br/>Press again to stop dispensing coffee.</p> <p><b>19</b> 1 coffee dispensing button.</p> <p><b>20</b> Hot water dispensing button.</p> <p><b>21</b> Water tank indicator light.</p> |
|---|--|

## 5. INSTALLATION

Before installing the unit, carefully read the safety instructions at the beginning of this manual.

1. Once the machine has been withdrawn from the packaging, follow the instructions given in the "GENERAL DELIVERY NOTES".
2. Position the unit on a horizontal surface.

### Arrange the accessories as follows:

3. Insert the ring (b1) inside the seat of the filter holder.
4. Insert one of the two filters (b0 or b6).

### Tank Model

5. Open the hatch (14) and take out the reservoir (1).
6. Especially the first time, wash the reservoir with soap and water.
7. Fill the reservoir with water and make certain that the outside of the reservoir is dry.
8. Return the reservoir (1) to its housing and close the hatch (14).

### Model for Direct connection to the water mains



**WARNING**

When connecting the mains water supply, always use a new pipe, suitable for this purpose.

5. Remove the tube from the hatch (14) on the top part of the machine.
6. Connect the end of the pipe to the fitting on the base of the machine.

7. Connect the other end of the tube with the 1/8" union to the mains water supply.

8. Make certain that the water drain tank (7) has been inserted.

Make certain that the cup support grill (8) is positioned squarely and is level.

9. Make sure that the steam knob (2) is closed, facing down.
10. Make certain that the line voltage corresponds to the requirements indicated on the label.
11. Only insert the plug in the socket if the steam knob (2) is closed and the mains voltage is the correct one.
12. The preliminary operations have been completed and the machine is ready to be set up.

**NOTE:** At the start of the day's activities and in any case, if there are any pauses of more than 8 hours, then it is necessary to change 100% of the water in the circuits, using the relevant dispensers.

**NOTE:** In case of use where service is continuous, make the above changes at least once a week.

## 6. PROGRAMMING

### 6.1 PROGRAMMING DOSES

To enter the programming mode, proceed as follows:

**NOTE:** the procedure can be carried out with the machine on.

- To enter the dose programming mode, it is necessary to press and hold down the continuous dispensing key  for 5 sec.
- The delivery keys will begin to flash.

### 6.2 COFFEE DOSE PROGRAMMING

To programme the amount of water for each of the delivery keys, proceed as follows:

- fill the filter holder with the right amount of coffee (the double or single filter holder can be used, according to the key to be programmed).
- Place the filter holder in the group.
- Press one of the delivery keys:





- Dispensing will commence; once the required quantity has been poured, press the same key again.



- Press the  key to quit the programming mode.

### 6.3 PROGRAMMING HOT WATER

- Use the relevant procedure to enter the programming function.
- Press the hot water selection key .
- Hot water delivery will begin.
- Decide the required amount of hot water and then press the key  again.
- Press the  key to quit the programming mode.

### 6.4 PROGRAMMING STANDARD DOSES



- It is possible to enter pre-set values for the group doses and hot water. To do this, it is necessary to press the key  and hold it down for at least 10 seconds until the flashing keys switch off.

The doses are:







1CN	2CN	CONT.	WATER
80 cc	120 cc	160 cc	45 sec.

**NOTE:** Setting a time of 0 seconds for the water causes it to operate in continuous mode.

### 6.5 ADDITIONAL FUNCTIONS

Also within the programming function (while no pouring is in progress), pressing the “” key and , then holding it down and pressing the “”, opens the page for setting the parameters:

- Software block activation to enter the dose programming mode.
- Keypad brightness adjustment.
- Dose pre-infusion activation.



- The  key serves to enable the software block to enter the dose programming mode (key lit) or disable it (key off). To remove a software block for programming, it is necessary to quit the dose programming mode and follow these steps: from OFF status, switch the control unit to ON and as soon as the Lamp-test begins, release the  key and press the  and  keys together, holding them down until the Lamp-test is complete.
- The  key, which flashes, is used to choose the brightness of the keys from the 9 pre-set levels. Pressing the  key will reduce the brightness setting as far as minimum, to then start again from the maximum value.
- Pressing the  key will start the pre-infusion (approx. 3 sec.) for dispensing (key lit) or it will switch it off (key off).

Pressing the  key will quit the parameter setting functions and return to the dose programming mode.

## 7. USE

Before starting to use any functions, the operator must first be sure to have read and understood the safety guidelines in this manual.

### 7.1 SWITCHING THE MACHINE ON/OFF

- Plug the machine into the mains socket; the LED of the on switch  will begin to flash.
- Hold down the on switch  for 2 seconds.
- The fact that the machine is operating is shown by the LED of the on switch  and all delivery keys, which remain lit.

For creamy coffee, wait about 25 minutes after switching on the machine.

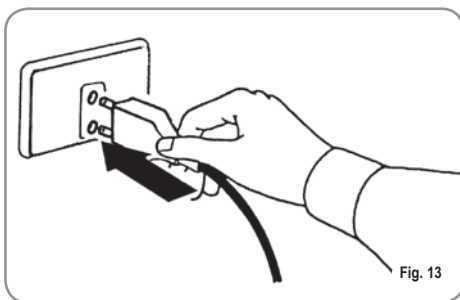



Fig. 13

**NOTE:** once the auto diagnosis has been completed all the keys are activated.



**WARNING**

For electronic card maintenance, turn the machine off by means of the external main switch or disconnect the plug.

- To switch off the machine, hold down the on switch  for 5 seconds; the LEDs on the delivery keys will switch off and the on switch LED will flash.

### 7.2 MAKING COFFEE

Unhitch the filter-holder and fill it with one or two doses of ground coffee depending on the filter used.

Replace, if necessary, using the relevant tool.

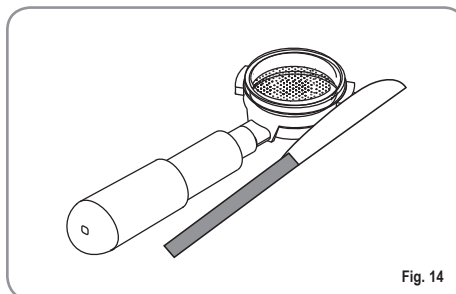

Fig. 14

The coffee doser (b4) when filled to the brim, provides the right amount for a single coffee. Put the coffee in the doser (b4) into the single filter (b6) or put 2 lots of coffee from the doser (b4) into the double filter (b0).

Press the coffee with the provided coffee presser, dust off any coffee residue from the rim of the filter (this way the rubber gasket will last longer).

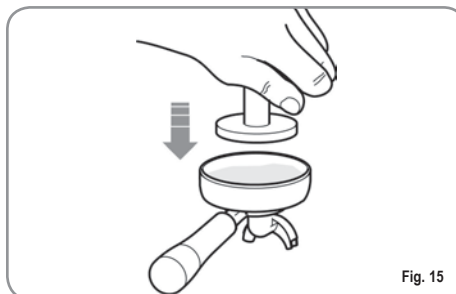

Fig. 15

Insert the filter in its unit.

Press the desired coffee button:



1 coffee



2 coffees



continued coffee

By starting up the coffee brewing procedure the unit's pump is activated and the unit's solenoid valve is opened.

By pressing it, the button will turn on and signal the operation.

**NOTE:** when in pause, leave the filter-holder inserted in the unit so that it will keep warm. To guarantee the utmost thermic stability during use, the delivery units are thermo-compensated with complete hot water circulation.

### 7.3 USING STEAM



**CAUTION  
DANGER OF BURNS**

While using the steam nozzle, you must pay attention to not place your hands beneath it or touch just after it has been used.

The steam wand can be used continuously for a maximum time of 45 secs.

To use the steam function, simply push the relevant lever (Fig. 16).

When pushed all the way, the lever remains blocked in the maximum dispensing position; when pulled, the lever automatically returns to its place.

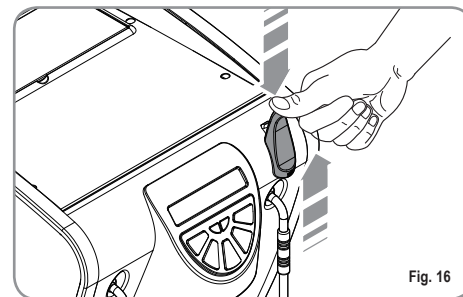

Fig. 16

**NOTE:** Before using the steam wand, always bleed out any condensation for at least 2 seconds or according to the manufacturer's instructions.

## 7.4 MAKING CAPPUCCINO

To obtain the typical cappuccino foam, immerse the nozzle all the way into a container 1/3 full of milk (preferably cone-shaped).

Turn on the steam. Before the milk starts to boil, pull the nozzle slightly up and lightly move it vertically across the surface of the milk.

When you have completed the procedure, clean the nozzle carefully with a soft cloth.

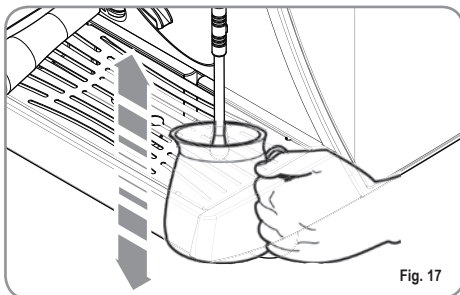

Fig. 17

## 7.5 HOT WATER SELECTION



**CAUTION**  
RISK OF BURNS OR SCALDING

While using the hot water nozzle, pay careful attention not to place your hands beneath it or touch it just after it has been used.

This nozzle delivers hot water to make tea or herb teas.

Place a container under the hot water wand and

press the hot water select key



Make sure the button lights up. Water will be delivered from the hot water nozzle for as long as the set time indicates.

**NOTE:** It is not possible to dispense hot water at the same time as coffee.

## 7.6 TANK FILLING

When the tank no longer has any water, the indicator

light  on the control panel will switch on.

To reset correct appliance operation, proceed as follows:

- Open the door and remove the tank.

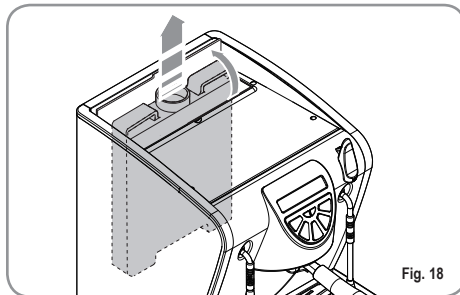

Fig. 18

- Fill the tank with mineral water (low lime content).

At the end of the operation, it is sufficient to refit the tank inside its compartment and close the door to restore the machine to the correct operating status.

**NOTE:** It is also possible to take out the tank when it is not empty; at this point, the liquid inside cannot come out from the bottom.

## 8. SWITCHING OFF THE MACHINE

To switch off the machine, press the (16) key, which will begin to flash.

It is also possible to switch the machine's main breaker (10) to off, causing all of the indicator lights to switch off.

**NOTE:** For long pauses and in the interests of safety, it is advisable to unplug the machine from the power mains.

## 9. MAINTENANCE

If the above-mentioned cleaning operations are performed, no other maintenance is required.

Contact the dealer where you purchased the unit for any operations required.

During maintenance/repairs, the parts used must be able to guarantee compliance with the safety and hygiene requirements envisaged for the device. Original replacement parts can offer this guarantee.

After repairs to/replacement of a part that comes into contact with foods or water, it is necessary to carry out a washing procedure or to follow the steps indicated by the manufacturer.

## 10. CLEANING

Except for cleaning of dispensing assembly (6) - shown in the table below - any other form of cleaning must be performed when the unit is in a condition of zero energy (off and unplugged from the power supply) and only after the hot parts have cooled to room temperature. See the table below:

N°	Item to be cleaned	Part N°	FREQUENCY		
			immediately after use	daily	weekly
1	Steam nozzle	5	■	■	■
2	Filter and filter holder	b2, b0, b6	■	■	■
3	Outside of the machine	a		■	■
4	Grill	8		■	■
5	Liquid tank	7	■	■	■
6	Water reservoir	1			■
7	Dispensing spout	6		■	
8	Gasket on the dispenser assembly	6		■	■
9	Dispenser assembly	6			■

### 1. Cleaning the steam nozzle.

Use a cloth dipped in hot water and/or a neutral detergent.

### 2. Cleaning the filter and filter holder.

- If necessary use a tool to pry the filter (b0/b6) out of the filter holder (b2).
- Rinse under a jet of water (tap) and dry.
- If necessary, use a small brush to clean out the filter.

### 3. Cleaning the outside of the machine.

- Never use any sort of solvent to clean the outside of the machine; use only a cloth dipped in hot water and a neutral soap.

### 4) Cleaning the grill.

- Brush the grill clean with hot water and soap.

### 5) Cleaning the liquid tank:

- Clean the liquid tank with hot water and soap, if necessary using a brush.

**NOTE:** the liquid tank can be washed in the dishwasher.

**CAUTION:** never use any sort of solvent.

### 6. Cleaning the water reservoir.

- Use soap and water and rinse thoroughly.
- NOTE:** if for any reason the water has left undesired scale, wash out with a swab.

### 7. Cleaning the dispensing spout.

- **CAUTION: DANGER OF BURNS:** this operation is performed with the unit on and for this reason requires utmost care.
- Clean the holes in the dispensing spout using a brush with slightly stiff bristles.
- Press the dispensing button (19) to unplug the holes.

### 8. Cleaning the gasket on the dispenser assembly.

- Use a small brush to clean away any scale or coffee residues from the gasket on the dispenser assembly.

### 9. Cleaning the dispenser assembly.

- Use a small brush to clean away any scale or coffee residues from the dispenser assembly spout.

## 11. TROUBLESHOOTING

If your espresso coffee maker is not functioning properly, see if you can find the problem in the troubleshooting list below. Also reread the corresponding sections in the user's manual.

Problem	Remedy
The machine does not prepare the espresso coffee.	Check whether the reservoir empty light is on: no water in the reservoir, or reservoir not inserted correctly. The coffee has been ground too fine or has been pressed too hard. The spout is plugged. Scale must be removed from the machine.
The coffee comes out of the sides of the filter holder.	The filter holder was not inserted correctly. The filter holder was not tightened enough. Clean coffee grinds away from the gasket (see the section on cleaning).
There is too little or no "cream".	Check the amount of coffee: the measure must be filled level. The machine is not hot: is the heating element off? The coffee has not been ground fine enough. The coffee in the filter has not been pressed correctly. The coffee is not fresh. The water is not fresh.
The "cream" is too dark and/or the coffee has a burnt flavor.	The coffee has been ground too fine. The coffee has been pressed too hard. Too much coffee has been measured.
The coffee is not hot enough.	The hot water passes through the filter too quickly. It takes 25-40 seconds to make 2 cups. The coffee in the filter has not been pressed correctly. The coffee has not been ground fine enough. The filter holder is cold. The filter holder should always left inserted in the machine while the unit is heating up and during use so it remains hot. The cups are cold. The cups must be placed on the heated shelf or preheated with hot water prior to use. The boiler safety thermostat has cut in: contact the nearest service center.
The pump does not suck water from the tank.	Open the steam nozzle (2) and press the coffee key (18) repeatedly.



# IMPIANTO ELETTRICO / ELECTRICAL SYSTEM / INSTALLATION ELECTRIQUE / ALEKTRISCHE ANLAGE / INSTALACIÒN ELÈCTRICA

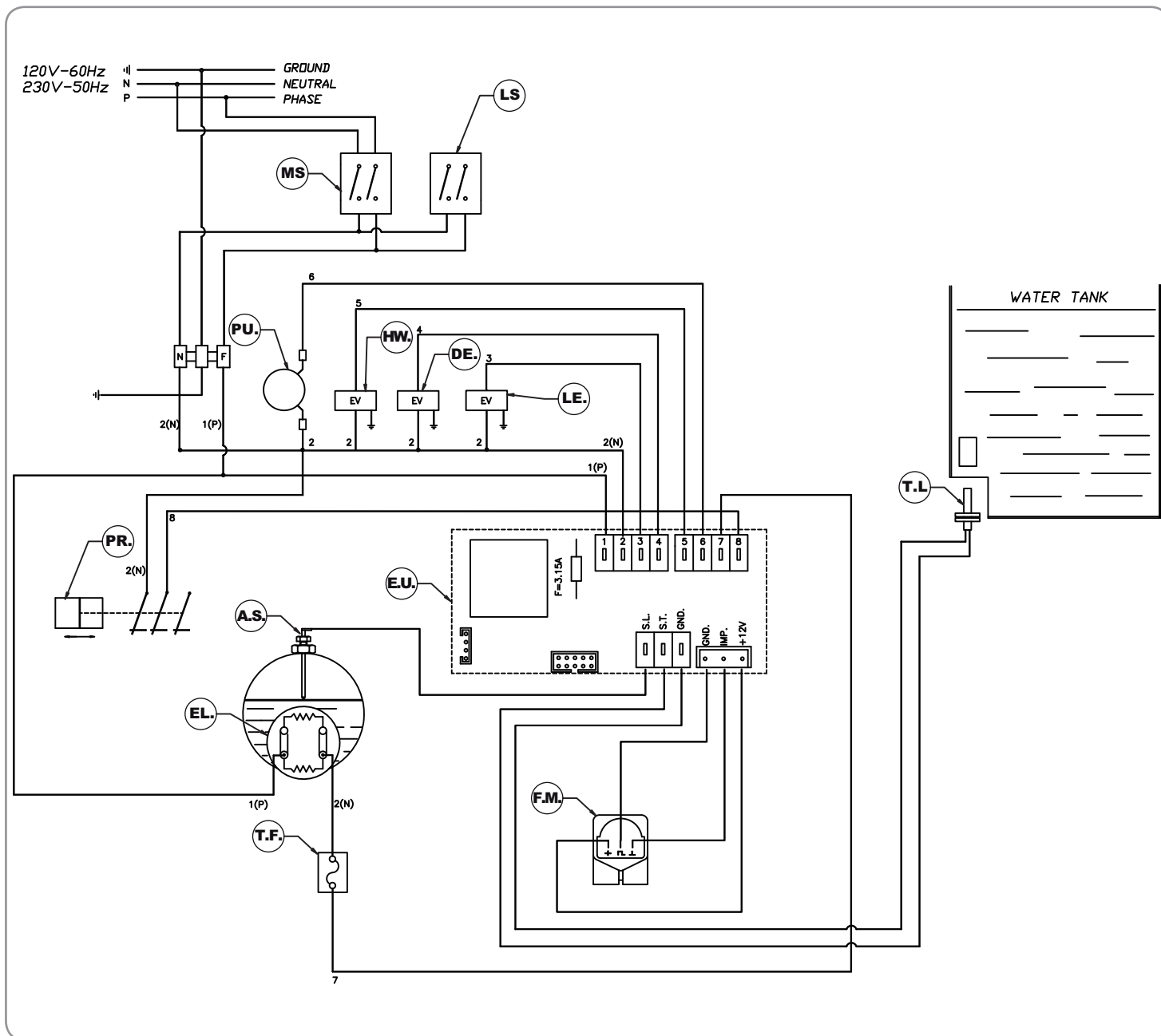

# IMPIANTO ELETTRICO / ELECTRICAL SYSTEM / INSTALLATION ELECTRIQUE / ALEKTRISCHE ANLAGE / INSTALACIÓN ELÉCTRICA

## LEGENDA

A.S. SENSORE AUTO LIVELLAMENTO  
M.S. INTERRUTTORE PRINCIPALE  
L.S. INTERRUTTORE LUCE  
E.U. UNITA' ELETTRONICA  
F.M. MISURATORE DI PORTATA  
T.L. SENSORE LIVELLO SERBATOIO  
PU. POMPA  
H.W. ELETTROVALVOLA ACQUA CALDA  
DE. ELETTROVALVOLA EROGATORE  
CAFFE'  
LE. ELETTROVALVOLA LIVELLO  
PR. PRESSOSTATO  
T.F. FUSIBILE  
EL. ELEMENTO

## LEGEND

A.S. AUTO LEVEL SENSOR  
M.S. MAIN SWITCH  
L.S. LIGHT SWITCH  
E.U. ELECTRONIC UNIT  
F.M. FLOW METER  
T.L. TANK LEVEL SENSOR  
PU. PUMP  
H.W. HOT WATER ELECTROVALVE  
DE. COFFEE DELIVERY ELECTROVALVE  
LE. LEVEL ELECTROVALVE  
PR. PRESSURE SWITCH  
T.F. THERMAL FUSE  
EL. ELEMENT

## LEGENDE

A.S. CAPTEUR MISE A NIVEAU  
AUTOMATIQUE  
M.S. INTERRUPTEUR PRINCIPAL  
L.S. INTERRUPTEUR ECLAIRAGE  
E.U. UNITE ELECTRONIQUE  
F.M. MESUREUR DE DEBIT  
T.L. CAPTEUR NIVEAU RESERVOIR  
PU. POMPE  
H.W. ELECTROVANNE EAU CHAUDE  
DE. ELECTROVANNE DISTRIBUTEUR  
CAFE  
LE. ELECTROVANNE NIVEAU  
PR. PRESSOSTAT  
T.F. FUSIBLE  
EL. ELEMENT

## LEGENDE

A.S. SELBSTNIVELLIERUNGSSENSOR  
M.S. HAUPTSCHALTER  
L.S. SCHALTER BELEUCHTUNG  
E.U. ELEKTRONISCHE STEÜREINHEIT  
F.M. DURCHFLUSSMESSER  
T.L. FÜLLSTANDSENSOR TANK  
PU. PUMPE  
H.W. MAGNETVENTIL HEISSWASSER  
DE. MAGNETVENTIL KAFFEEAUSGUSS  
LE. MAGNETVENTIL FÜLLSTAND  
PR. DRUCKSCHALTER  
T.F. SCHMELZSICHERUNG  
EL. ELEMENT

## LEYENDA

A.S. SENSOR AUTO NIVELADO  
M.S. INTERRUPTOR PRINCIPAL  
L.S. INTERRUPTOR LUZ  
E.U. UNIDAD ELECTRÓNICA  
F.M. MEDIDOR DE CAPACIDAD  
T.L. SENSOR NIVEL DEPÓSITO  
PU. BOMBA  
H.W. ELECTROVÁLVULA AGUA  
CALIENTE  
DE. ELECTROVÁLVULA EROGADOR  
CAFÉ  
LE. ELECTROVÁLVULA NIVEL  
PR. PRESOSTATO  
T.F. FUSIBLE  
EL. ELEMENTO

**CENTRALINA / CONTROL UNIT / CENTRALE**  
**/ STEUERUNG / CENTRALITA**

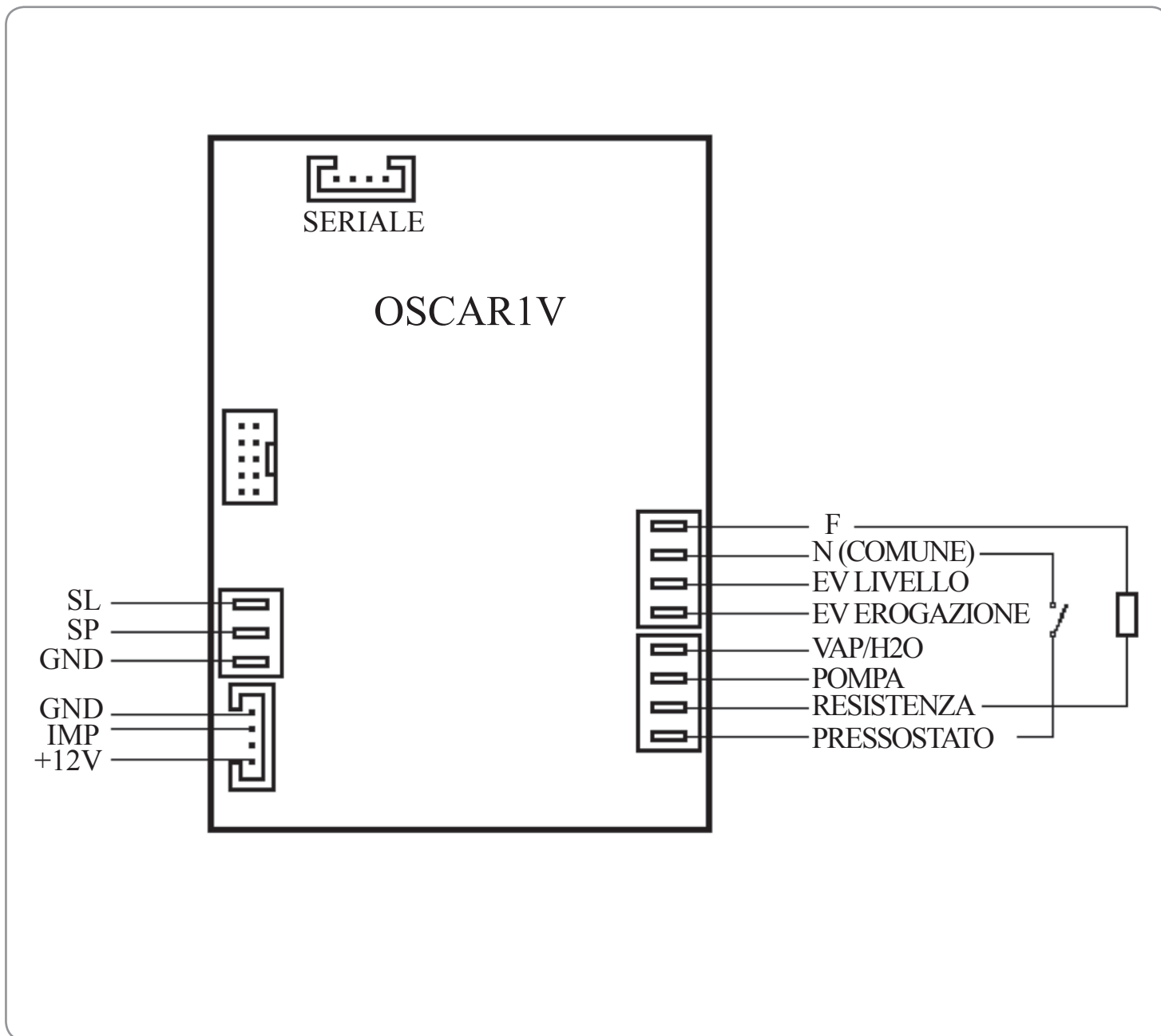

## CENTRALINA / CONTROL UNIT / CENTRALE / STEUERUNG / CENTRALITA

### LEGENDA

SL  
SP  
GND  
IMP  
+12V  
F  
N(Comune)  
EV LIVELLO  
EV EROGAZIONE  
VAP/H2O  
POMPA  
RESISTENZA  
PRESSOSTATO

### LEGEND

SL  
SP  
GND  
IMP  
+12V  
F  
N (Common)  
LEVEL ELECTROVALVE  
DELIVERY ELECTROVALVE  
STEAM/WATER  
PUMP  
ELEMENT  
PRESSURE SWITCH

### LEGENDE

SL  
SP  
GND  
IMP  
+12V  
F  
N(Commun)  
EV NIVEAU  
EV DISTRIBUTION  
VAP/H2O  
POMPE  
RESISTANCE  
PRESSOSTAT

### LEGENDE

SL  
SP  
GND  
IMP  
+12V  
F  
N( Nullleiter)  
EV FÜLLSTAND  
EV AUSGUSS  
VAP/H2O (DAMPF/WASSER)  
PUMPE  
WIDERSTAND  
DRUCKSCHALTER

### LEYENDA

SL  
SP  
GND  
IMP  
+12V  
F  
N (Común)  
EV NIVEL  
EV EROGACIÓN  
VAP/H2O  
BOMBA  
RESISTENCIA  
PRESOSTATO

# IMPIANTO IDRAULICO / PLUMBING SYSTEM / INSTALLATION HYDRAULIQUE / HYDRAULIKANLAGE / INSTLACIÓN HIDRÁULICA

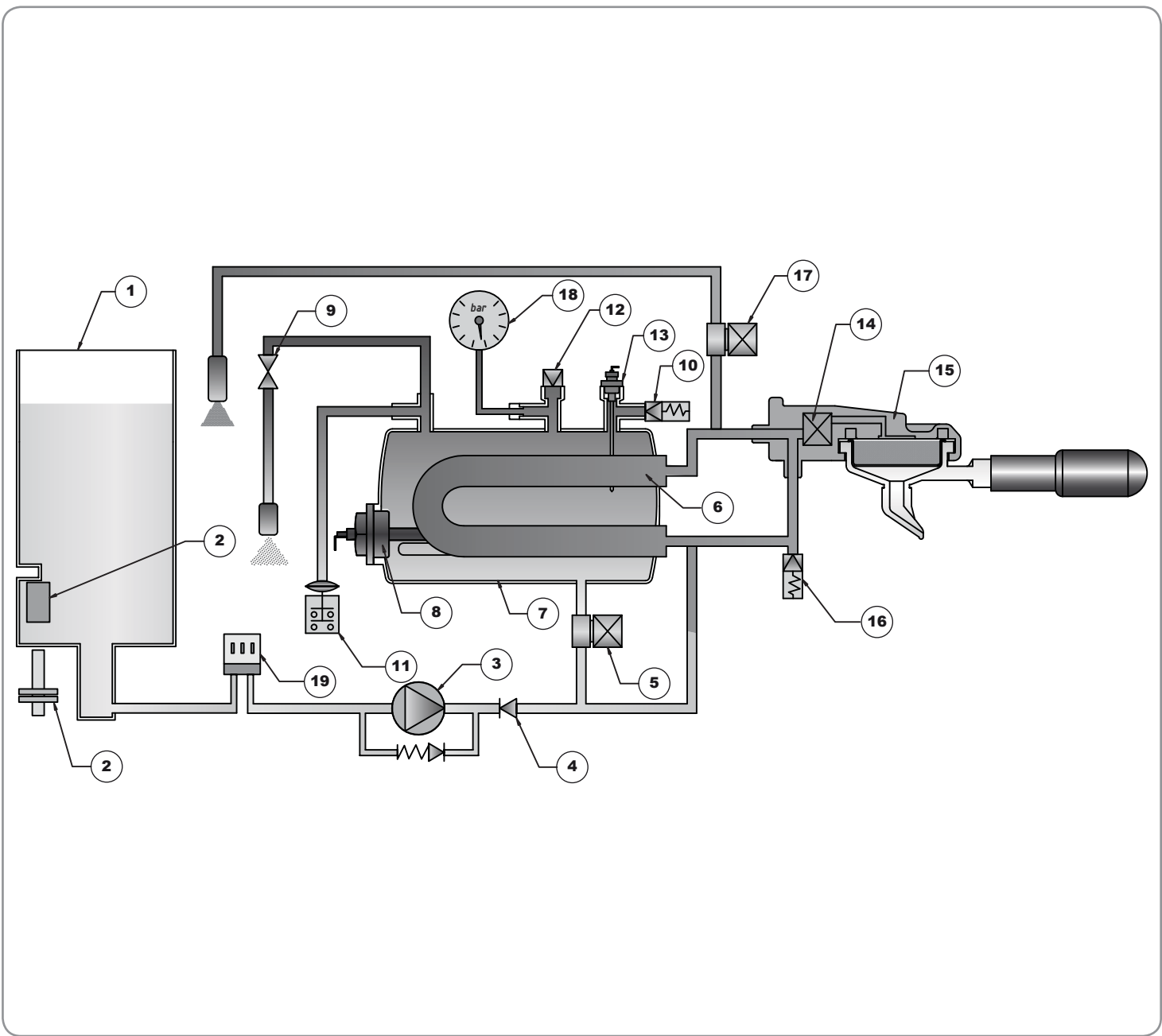

# IMPIANTO IDRAULICO / PLUMBING SYSTEM / INSTALLATION HYDRAULIQUE /HYDRAULIKANLAGE / INSTLACIÓN HIDRÁULICA

## LEGENDA

1. SERBATOIO ACQUA
2. SONDE SERBATOIO
3. POMPA
4. VALVOLA DI NON RITORNO
5. ELETTROVALVOLA LIVELLO
6. SCAMBIATORE DI CALORE
7. BOILER
8. ELEMENTO RISCALDANTE
9. VALVOLA DI SISTEMA
10. VALVOLA DI SICUREZZA
11. PRESSOSTATO
12. VALVOLA ANTI-VUOTO
13. SONDA DI LIVELLO
14. ELETTROVALVOLA EROGAZIONE
15. GRUPPO
16. VALVOLA DI ESPANSIONE
17. ELETTROVALVOLA ACQUA CALDA
18. MANOMETRO BOILER
19. MISURATORE DI PORTATA

## LEGEND

1. WATER TANK
2. PROBES TANK
3. PUMP
4. RETAINING VALVE
5. LEVEL SOLENOID
6. HEAT EXCHANGER
7. BOILER
8. HEATING ELEMENT
9. SYSTEM VALVE
10. SAFETY VALVE
11. PRESSOSTAT
12. ANTI-VACUUM VALVE
13. LEVEL PROBE
14. DELIVERY SOLENOID
15. GROUP
16. EXPANSION VALVE
17. HOT WATER SOLENOID
18. BOILER PRESSURE METER
19. FLOW METER

## LEGENDE

1. RESERVOIR EAU
2. SONDES RESERVOIR
3. POMPE
4. SOUPE DE NON RETOUR
5. ELECTROVANNE NIVEAU
6. ECHANGEUR DE CHALEUR
7. CHAUFFE-EAU
8. ELEMENT DE RECHAUFFEMENT
9. SOUPE DE SYSTEME
10. SOUPE DE SURETE
11. PRESSOSTAT
12. SOUPE ANTI-VIDE
13. SONDE DE NIVEAU
14. ELECTROVANNE DISTRIBUTION
15. GROUPE
16. SOUPE D'EXPANSION
17. ELECTROVANNE EAU CHAUDE
18. MANOMETRE CHAUFFE-EAU
19. MESUREUR DE DEBIT

## LEGENDE

1. WASSERTANK
2. SONDEN TANK
3. PUMPE
4. RÜCKSCHLAGVENTIL
5. MAGNETVENTIL FÜLLSTAND
6. WÄRMEAUSTAUSCHER
7. BOILER
8. HEIZELEMENT
9. SYSTEMVENTIL
10. SICHERHEITSVENTIL
11. DRUCKSCHALTER
12. ANTIVAKUUM- VENTIL
13. FÜLLSTANDSONDE
14. MAGNETVENTIL AUSGUSS
15. GRUPPE
16. AUSDEHNUNGSVENTIL
17. MAGNETVENTIL HEISSWASSER
18. MANOMETER BOILER
19. DURCHFLUSSMESSER

## LEYENDA

1. DEPÓSITO AGUA
2. SONDAS DEPÓSITO
3. BOMBA
4. VÁLVULA SIN RETORNO
5. ELE ELECTROVÁLVULA NIVEL
6. INTERCAMBIADOR DE CALOR
7. CALENTADOR
8. ELEMENTO CALENTADOR
9. VÁLVULA DE SISTEMA
10. VÁLVULA DE SEGURIDAD
11. PRESOSTATO
12. VÁLVULA ANTI-VACÍO
13. SONDA DE NIVEL
14. ELE ELECTROVÁLVULA EROGACIÓN
15. GRUPO
16. VÁLVULA DE EXPANSIÓN
17. ELE ELECTROVÁLVULA AGUA CALIENTE
18. MANÓMETRO CALENTADOR
19. MEDIDOR DE CAPACIDAD





Nuova Distribution Centre  
LLC 6940Salashan PKWY BLDG A 98248 Ferdale, WA  
Tel. +1.360.3662226  
Fax +1.3603664015  
videoconf.+1.360.3188595  
[www.nuovasimonelli.it](http://www.nuovasimonelli.it)  
[info@nuovasimonelli.com](mailto:info@nuovasimonelli.com)



Via M. d'Antegiano, 6  
62020 Belforte del Chienti  
Macerata Italy  
Tel. +39.0733.9501  
Fax +39.0733-950242  
[www.nuovasimonelli.it](http://www.nuovasimonelli.it)  
E-mail: [n.simonelli@nuovasimonelli.it](mailto:n.simonelli@nuovasimonelli.it)